

LEGEND	
	REGIONAL ARTERIAL
	ISLAND ARTERIAL
	ISLAND COLLECTOR
	LOCAL STREET

# ALAMEDA POINT MASTER INFRASTRUCTURE PLAN STREET TYPE

CITY OF ALAMEDA ALAMEDA COUNTY CALIFORNIA

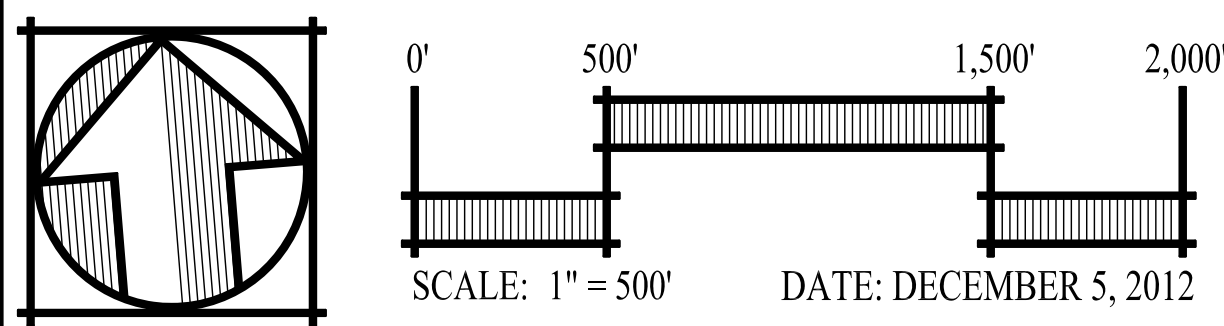

**cbg** Carlson, Barbee & Gibson, Inc.  
CIVIL ENGINEERS • SURVEYORS • PLANNERS

6111 BOLLINGER CANYON ROAD, SUITE 150 (925) 866-0322  
SAN RAMON, CALIFORNIA 94583 FAX (925) 866-8575

SAN RAMON • LATHROP



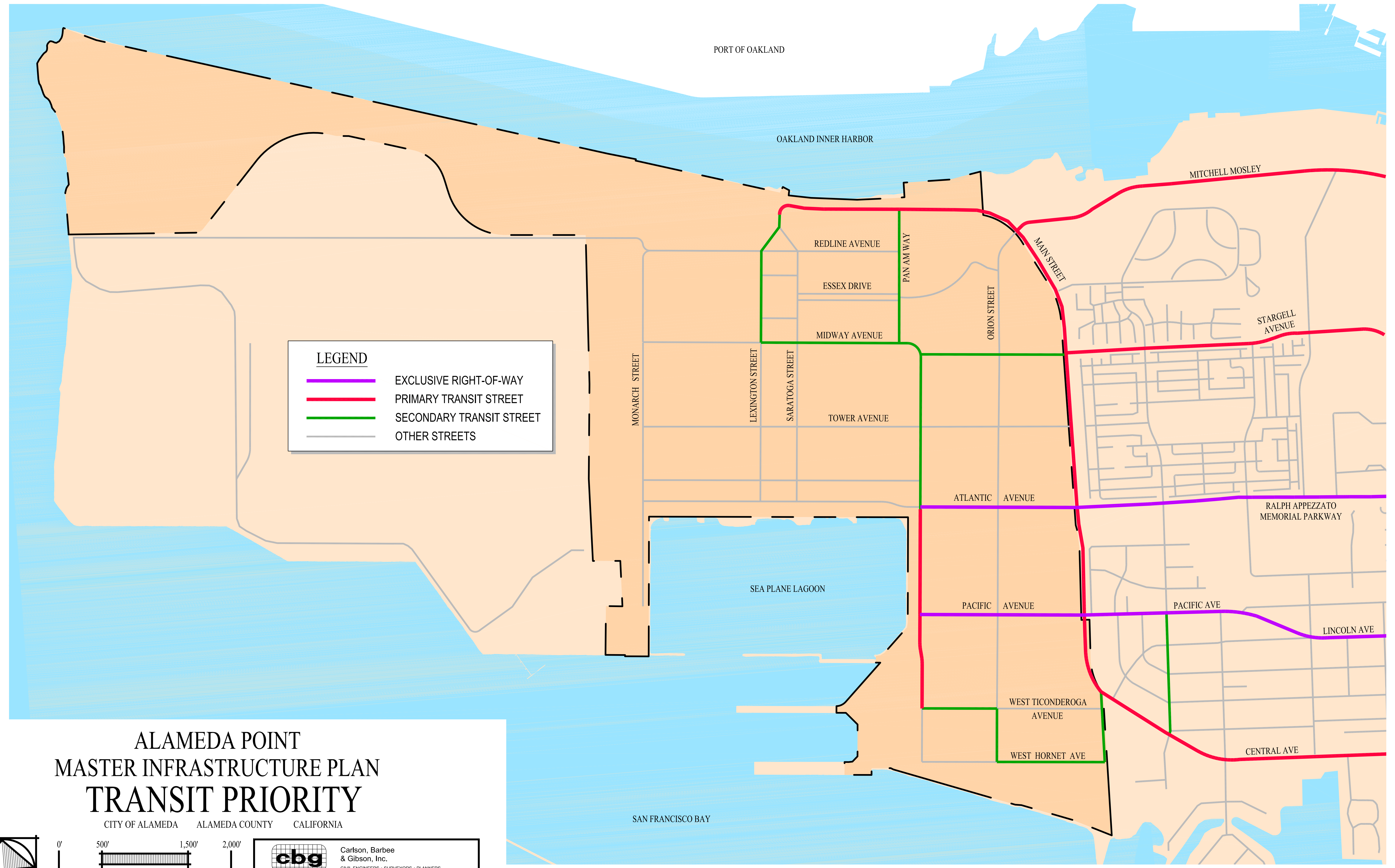

**LEGEND**

- EXCLUSIVE RIGHT-OF-WAY
- PRIMARY TRANSIT STREET
- SECONDARY TRANSIT STREET
- OTHER STREETS

# ALAMEDA POINT MASTER INFRASTRUCTURE PLAN TRANSIT PRIORITY

CITY OF ALAMEDA    ALAMEDA COUNTY    CALIFORNIA

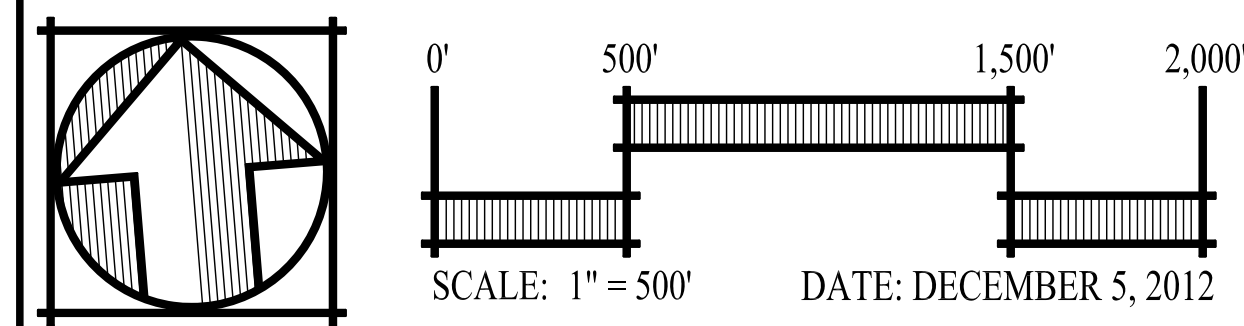



**cbg** Carlson, Barbee & Gibson, Inc.  
 CIVIL ENGINEERS • SURVEYORS • PLANNERS  
 6111 BOLLINGER CANYON ROAD, SUITE 150    (925) 866-0322  
 SAN RAMON, CALIFORNIA 94583    FAX (925) 866-8575  
 SAN RAMON • LATHROP

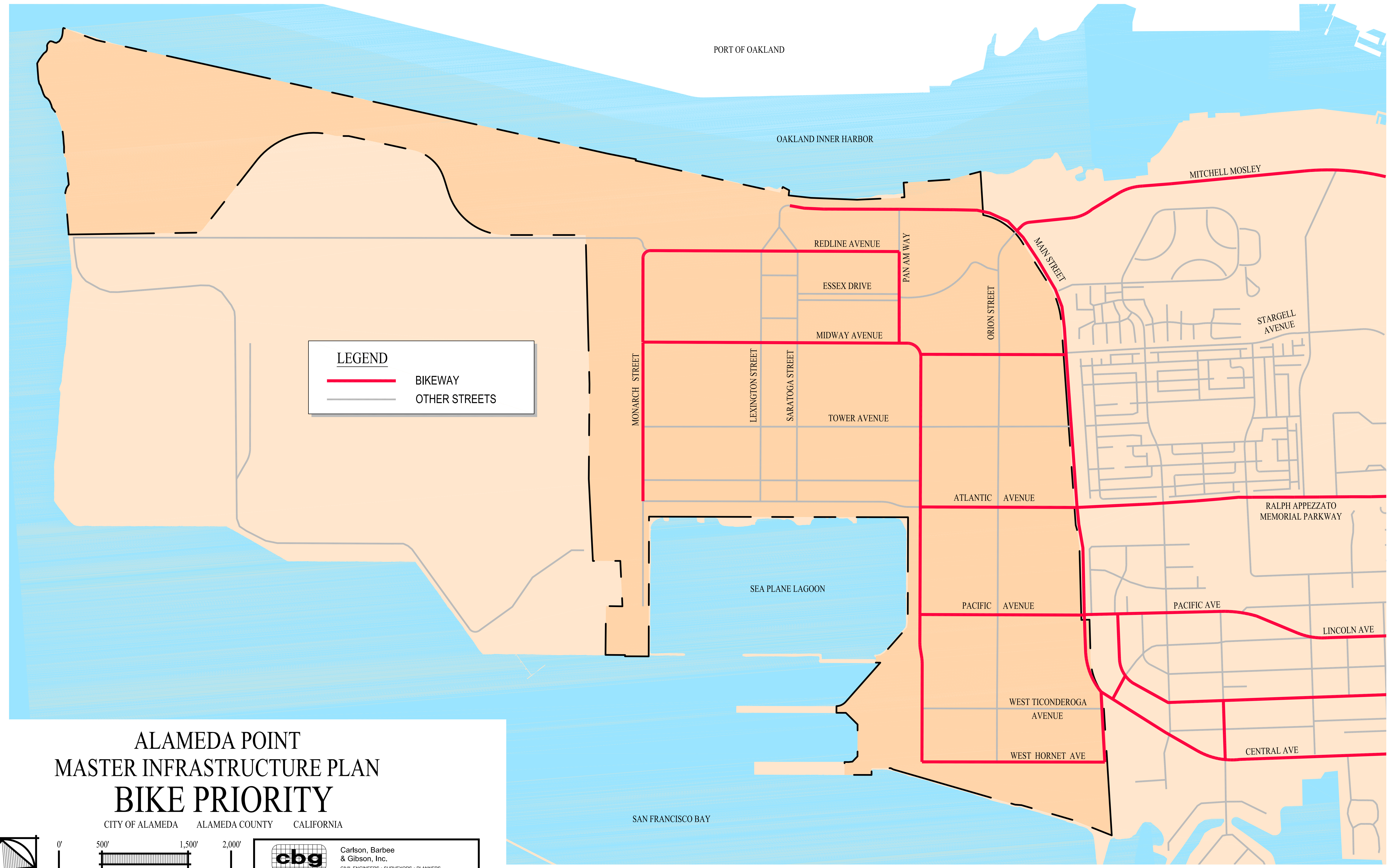



**LEGEND**

 BIKEWAY

 OTHER STREETS

ALAMEDA POINT  
 MASTER INFRASTRUCTURE PLAN  
**BIKE PRIORITY**  
 CITY OF ALAMEDA ALAMEDA COUNTY CALIFORNIA

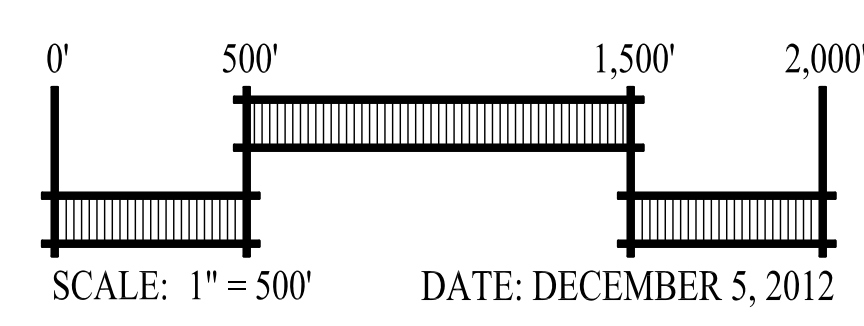
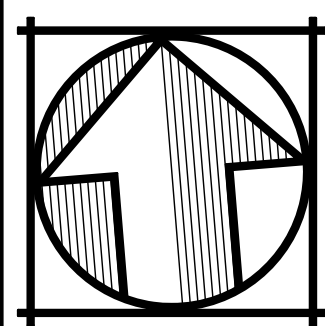

**cbg** Carlson, Barbee & Gibson, Inc.  
 CIVIL ENGINEERS • SURVEYORS • PLANNERS

6111 BOLLINGER CANYON ROAD, SUITE 150 (925) 866-0322  
 SAN RAMON, CALIFORNIA 94583 FAX (925) 866-8575  
 SAN RAMON • LATHROP



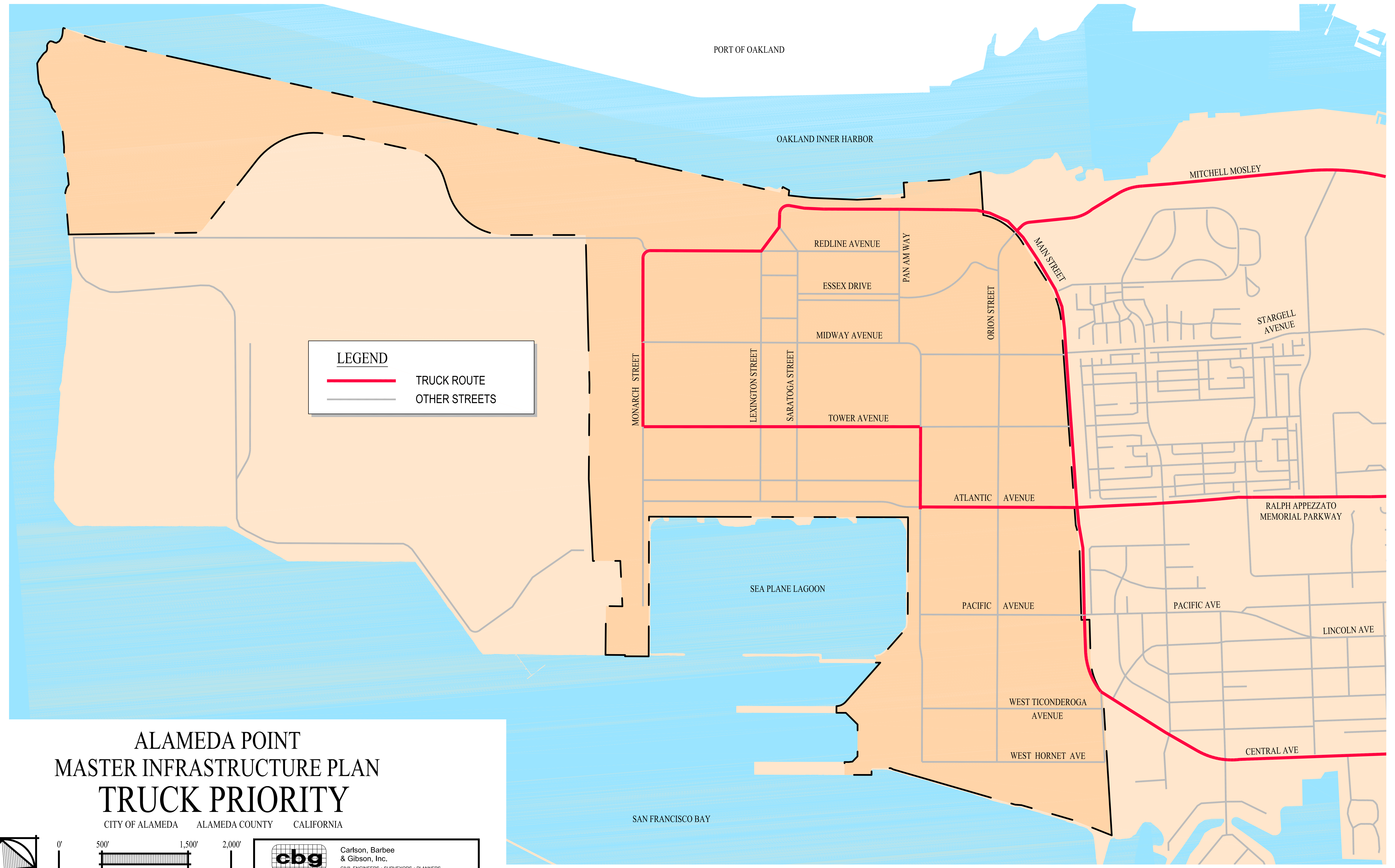

# ALAMEDA POINT MASTER INFRASTRUCTURE PLAN TRUCK PRIORITY

CITY OF ALAMEDA ALAMEDA COUNTY CALIFORNIA

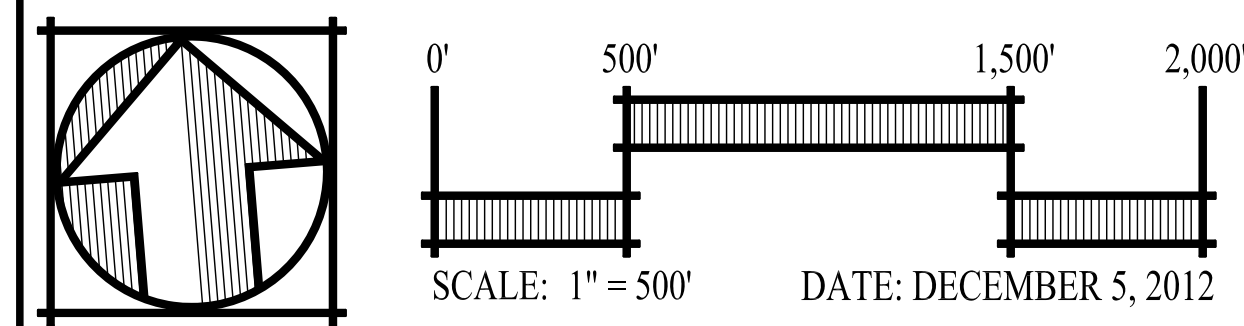

**cbg** Carlson, Barbee & Gibson, Inc.  
CIVIL ENGINEERS • SURVEYORS • PLANNERS

6111 BOLLINGER CANYON ROAD, SUITE 150 (925) 866-0322  
SAN RAMON, CALIFORNIA 94583 FAX (925) 866-8575

SAN RAMON • LATHROP